

GLOBO

LIGHTING

480250BSH

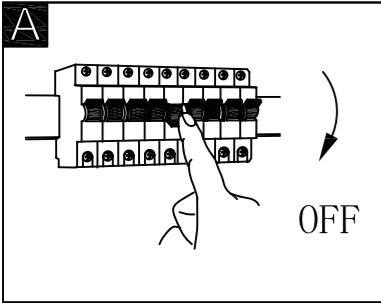

smart voice control 

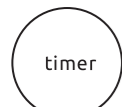

B





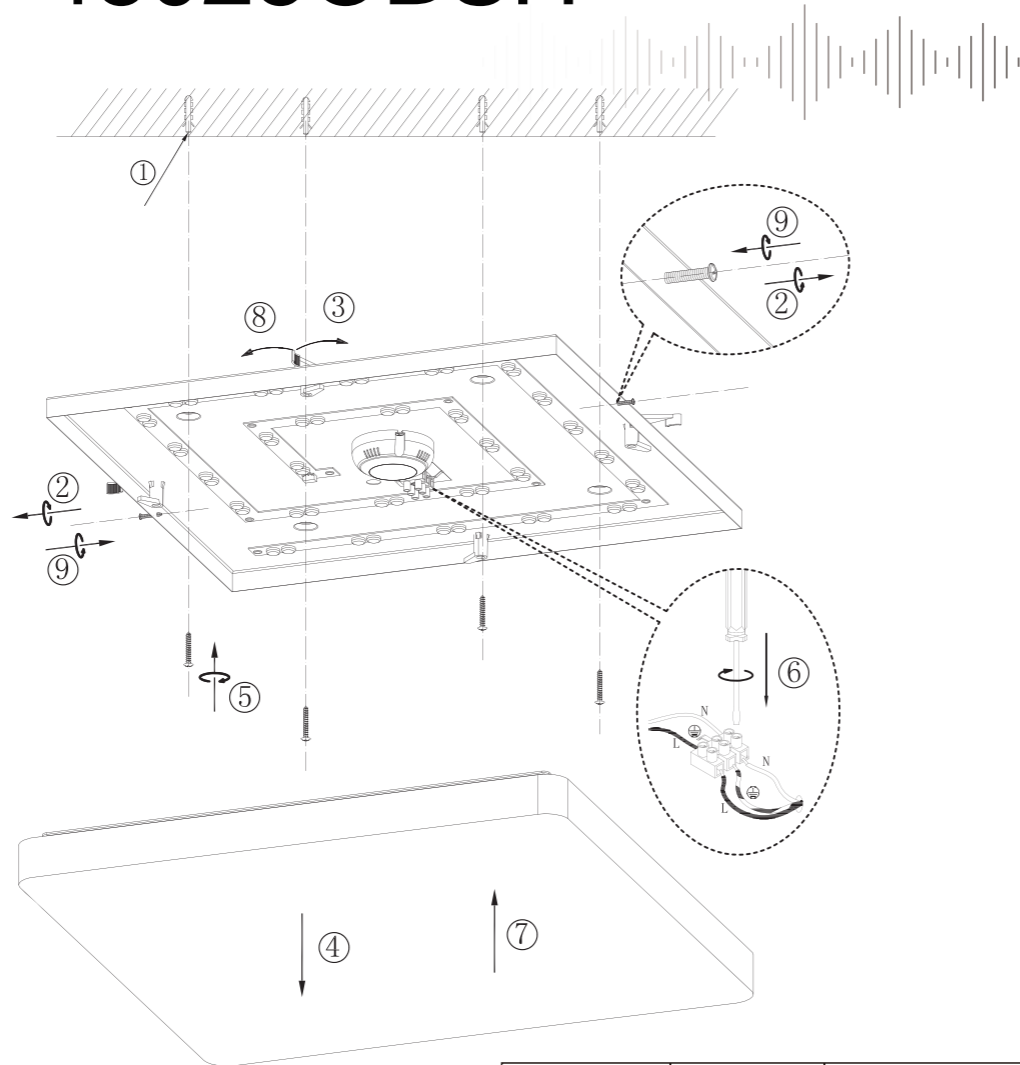

-  timer
-  colour change
-  incl.
-  dimmable
-  night light
-  LED
-  memory function

smart APP control

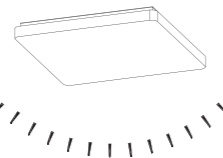
- free APP
- compatible with Alexa 
- compatible with Google Assistant 

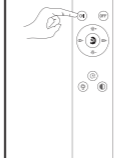

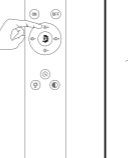
Frequency Bandwidth	Maximal radiation transmitting power	1x24W LED 245-255V 220-240V~ 50/60Hz
2400-2483.5MHz	<7dBm	

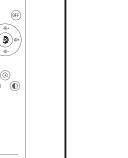
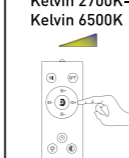
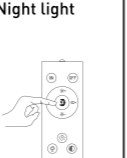
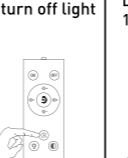
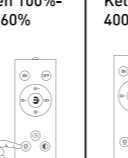
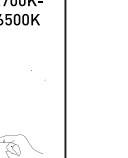
	ON	OFF	Lumen 	Lumen 	Kelvin 6500K- Kelvin 2700K
	Kelvin 2700K- Kelvin 6500K	Night light	60s turn off light	Lumen 100%- 15%-60%	Kelvin 2700K- 4000K-6500K
					
					

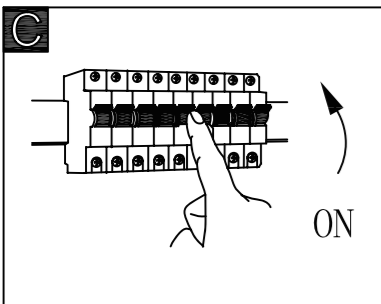

Download Tuya App:



Get latest manual:





Functional Video:

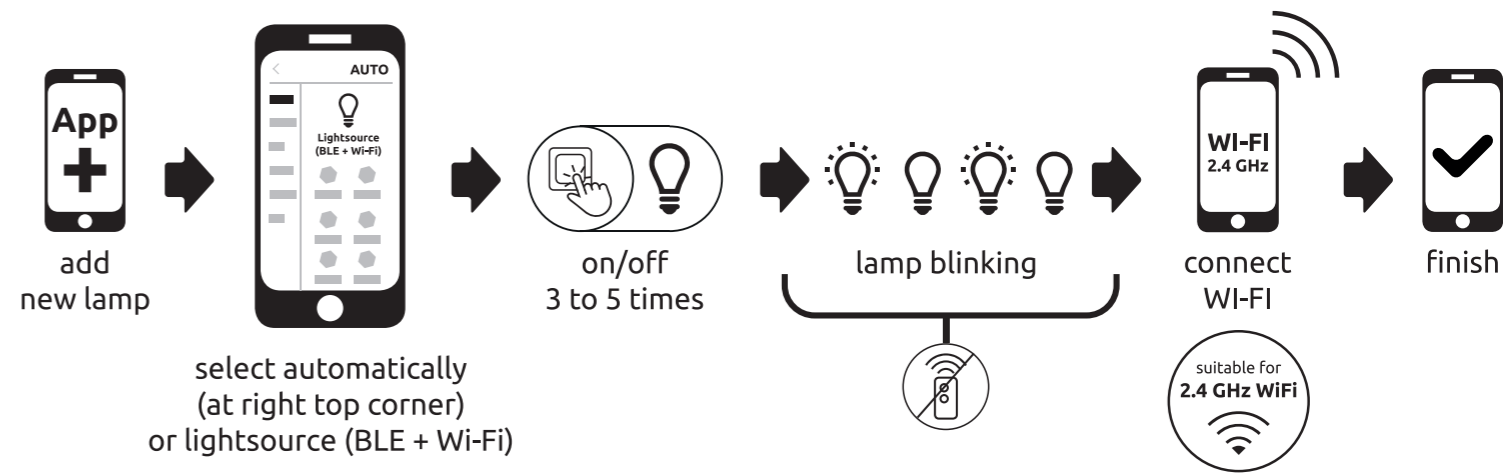

Tuya App - Pairing Process



 08:00 to 16:00
(Monday to Friday)

 +43 (0)4253 320 50 083

(Please consider, your telephone operator's usual charges for calls to Austria will apply.)

GLOBO Handels GmbH
 Gewerbstrasse 3
 A-9184 Sankt Peter, AUSTRIA
 www.globo-lighting.com
 office@globo-lighting.com

Lichtquelle / Light Source:

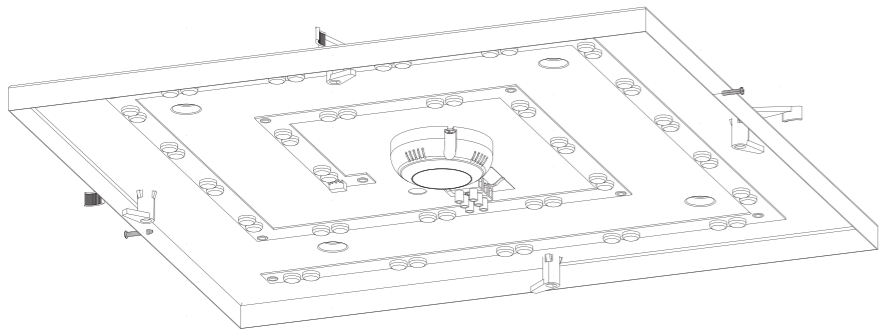



DEU:
Lichtquelle:
Die Lichtquelle ist nicht tauschbar, weil sie konstruktionsbedingt fest mit dem umgebenden Produkt verbunden ist. Dieses Produkt enthält eine Lichtquelle der Energieeffizienzklasse <F>.

 Das Betriebsgerät ist nicht austauschbar.

 Die LED - Lichtquelle ist nicht austauschbar.

GBR:
Light source:
The light source is not interchangeable because it is determined by the surrounding product design. This product contains a light source of energy efficiency class <F>.

 The control gear cannot be replaced.

 The LED - light source cannot be replaced.

BIH & HR:
Izvor svjetla :
Izvor svjetla nije zamjenjiv , jer je konstrukcijski pričvršćen na proizvod . Ovaj proizvod sadržava izvor svjetlosti klase energetske učinkovitosti <F>.

 Pogonski uređaj se ne može zamjeniti .

 LED –izvor svjetla nije moguće zamjeniti

BG:
Източник на светлина:
Източникът на светлина не може да се подменя, тъй като поради конструкцията си е трайно фиксиран към заобикалящия го продукт.
Този продукт включва светлинен източник с клас на енергийна ефективност <F>.

 Устройството за управление не може да се подменя.

 LED източникът на светлина не може да се подменя.

CZ:
Zdroj světla:
Světelný zdroj není možné vyměnit, protože je díky své konstrukci pevně spojený s produktem. Tento výrobek obsahuje světelný zdroj s třídou energetické účinnosti <F>.

 Předřadník není vyměnitelný.

 Světelný zdroj není vyměnitelný.

DK:
Lyskilde:
Lyskilden kan ikke udskiftes, fordi den er fast bundet med det omgivende produkt. Dette produkt indeholder en lyskilde i energieffektivitetsklasse < F >.

 Driftsenheden kan ikke udskiftes.

 LED- lyskilden kan ikke udskiftes.

ET:
Valgusallikas:
Valgusallikas ei ole välja vahetatav, sest ta on tooteга ehituslikult kindlalt seotud. Toode sisaldab energiatõhususe klassi <F> valgusallikat.

 Juhtseadet ei saa asendada.

 LED - valgusallikat ei saa asendada.

ES:
Fuente de luz:
La fuente de luz no es sustituible porque está fija en el producto desde la construcción. Este producto contiene una fuente luminosa de la clase de eficiencia energética <F>.

 Dispositivo de control no reemplazable.

 Bombilla no reemplazable.

FI:
Valonlähde:
Valonlähdettä ei voi vaihtaa uuteen, sillä se on rakenteellisesti yhdistetty ympäröivään tuotteeseen. Tämä tuote sisältää valonlähteen, jonka energiatehokkuusluokka on <F>.

 Liitäntälaitetta ei voi vaihtaa uuteen.

 LED-valonlähdettä ei voi vaihtaa uuteen.

FR:
Source lumineuse:
La source lumineuse n'est pas remplaçable car elle est, de par la construction du produit, liée de façon permanente à celui-ci. Ce produit contient une source lumineuse de classe d'efficacité énergétique <F>.

 L'unité de contrôle n'est pas remplaçable.

 La source lumineuse LED n'est pas remplaçable.

GR:
Φωτεινή πηγή:
Η φωτεινή πηγή δεν μπορεί να αντικατασταθεί, επειδή είναι για κατασκευαστικούς λόγους σταθερά συνδεδεμένη με το προϊόν που την περιβάλλει.
Το προϊόν αυτό περιέχει φωτεινή πηγή της τάξης ενεργειακής απόδοσης <F>.

 Η λειτουργική συσκευή δεν αντικαθίσταται.

 Η φωτεινή πηγή LEDδεν αντικαθίσταται.

HU:
Fényforrás:
A fényforrás nem cserélhető, mert felépítése miatt szilárdan csatlakozik a termékhez. Ez a termék egy <F> energiahatékonysági osztályú fényforrást tartalmaz.

 Az előtét nem cserélhető.

 A fényforrás nem cserélhető

Isländisch/IS:
Ljósgrjafi:
Ljósgrjafinn er ekki útskiptanlegur vegna þess að hann er háður umliggjandi hönnun vörunnar. Varan inniheldur ljósgrjafa í orkuflokki <F>.

 Ekki er hægt að skipta um stjórnbúnaðinn.

 Ekki er hægt að skipta um LED-ljósgrjafann.

IT:
Sorgente luminosa:
La sorgente luminosa non è intercambiabile perché è saldamente collegata al prodotto per via del suo design. Questo prodotto contiene una sorgente luminosa di classe di efficienza energetica <F>.

 La centralina non può essere sostituita

 La sorgente luminosa a LED non può essere sostituita.

LV:
Gaismas avots:
Gaismas avotu nevar nomainīt, jo tas konstrukcijā ir cieši savienots ar izstrādājuma apkārtējo daļu. Šis ražojums satur gaismas avotu, kura energoefektivitātes klase ir <F>.

 Vadības ierīci nevar nomainīt.

 LED apgaismes līdzekli nevar nomainīt.

LT:
Šviesos šaltinis:
Šis šviesos šaltinis yra nekeičiamas, nes jis prijungtas prie gaminio pagal jo konstrukciją. Šiame gaminyje yra šviesos šaltinis, kurio energijos vartojimo efektyvumo klasė <F>.

 Vadības ierīci nevar nomainīt.

 LED šviesosšaltinisyra nekeičiamas.

NL:
Lichtbron:
De lichtbron kan niet worden vervangen, omdat deze vanwege de constructie vast met het product eromheen verbonden is. Dit product bevat een lichtbron van energie-efficiëntieklasse <F>.

 Het apparaat kan niet worden vervangen.

 De LED-lichtbron kan niet worden vervangen.

Norwegisch/Norwegian / NO:
Lyskilde:
Lyskilden kan ikke byttes fordi den sitter fast i produktet. Dette produktet inneholder en lyskilde i energiklasse <F>.

 Drivereheten kan ikke byttes.

 LED-lyspæren kan ikke byttes.

PL:
Źródło światła:
Źródła światła nie można wymenić, ponieważ jest zintegrowane z produktem ze względu na swoją konstrukcję. Ten produkt zawiera źródło światła o klasie efektywności energetycznej <F>.

 Niemożnawymenićprzekładnisterującej.

 LED - źródłowiattłaniemożebyćwymienione.

PT:
Fonte de Luz:
A fonte de luz não é substituível porque devido às suas características construtivas está fixada de forma permanente ao produto circundante. Este produto contém uma fonte de luz da classe de eficiência energética <F>.

 Equipamento de controlo não substituível.

 Lâmpada não substituível.

RO:
Sursa de lumina:
Sursa de lumina nu este inlocuibila ea fiind parte constructiva a produsului Acest produs conține o sursă de lumină cu clasa de eficiență energetică <F>.

 Driverul nu poate fi inlocuit

 Sursa de lumina nu poate fi inlocuita

RUS:
Источник света:
Источник света не является взаимозаменяемым, поскольку это определяется конструкцией смежного продукта. Данный продукт содержит источник света класса энергоэффективности <F>.

 Устройство управления не подлежит замене.

 Светодиодный источник света не подлежит замене.

SRB:
Izvor svetlosti:
Izvor svetlosti nije zamenljiv, jer je zbog svog dizajna čvrsto povezan sa proizvodom koji ga opkružuje. Ovaj proizvod sadrži izvor svetlosti klase energetske efikasnosti <F>.

 Upravljački uređaj nije zamenljiv.

 LED izvor svetlosti nije zamenljiv.

SK:
Zdroj svetla:
Svetelný zdroj nie je možné vymeniť, pretože je vďaka svojej konštrukcii pevne spojený s produktom. Tento výrobok obsahuje svetelný zdroj triedy energetickej účinnosti <F>.

 Predradníknie je vymeniteľný.

 Svetelný zdroj nie je vymeniteľný.

SI:
Izvor svetlobe:
Vir svetlobe ni zamenljiv, ker je določen z zasnovno izdelka v okolici. Ta izdelek vsebuje svetlobni vir razreda enerjske učinkovitosti <F>.

 Krmilniknimožezamenjati.

 Svetlobnivirmožezamenjati.

SE:
Ljuskälla:
Ljuskällan är inte utbytbar, eftersom den på grund av konstruktionen är fast integrerad i den omgivande produkten. Denna produkt innehåller en ljuskälla med energieffektivitetsklass <F>.

 Driftdonet kan inte bytas ut.

 LED-ljuskällan kan inte bytas ut.

TR:
Işık kaynağı:
Konstrüksiyon gereği çevreleyen ürün ile sabit bir şekilde bağlı olduđu için ışık kaynağı deđiştirilemez. Bu ürün, <F>enerji sınıfından bir ışık kaynağına sahiptir.

 İşletme cihazı deđiştirilemez.

 LED ışık kaynağı deđiştirilemez.

UK:
Джерелосвітла:
Джерелосвітланеможаобмінати, оскількивономіцнопов'язанезнаволишнімвиробомзавдякисвоїйконструкції. Цей виріб містить джерело світла класу енергоефективності <F>.

 пристрійкеруванняне можназамінювати.

 джерелосвітлодіодногосвітла неможназамінювати.